

1 Allée des Bouleaux -F-95110 SANNOIS
 +33 (0)1 39 98 55 00
 info@restagraf.com

FUSIBLE PLAT MAXICOMPACT 40A

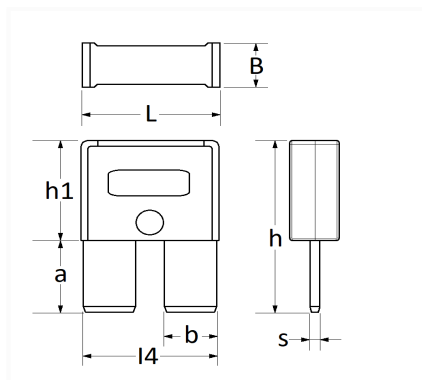

Code article	Nb de références	Nb de pièces	Conditionnement
217506	1	2	BLISTER
17506	1	5	SACHET



Informations techniques		
L		16.2 mm
B		6.5 mm
h		20 mm
h1		11.5 mm
a		8.5 mm
b		6.3 mm
l4		15.45 mm
s		0.81 mm
Intens.		40 A

Matières

CUIVRE ÉTAMÉ

Correspondances constructeurs*

CITROËN	9836305080	DS AUTOMOBILES	9836305080
---------	------------	----------------	------------

Correspondances constructeurs*

OPEL (Stellantis)	9836305080	PEUGEOT	9836305080
-------------------	------------	---------	------------

* Informations non contractuelles données à titre indicatif
