

1 Allée des Bouleaux -F-95110 SANNOIS
 +33 (0)1 39 98 55 00
 info@restagraf.com

AGRAFE DE TRINGLE Ø 4 mm SERRURE DE PORTE

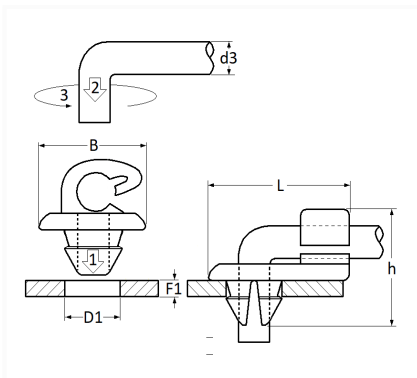

Code article	Nb de références	Nb de pièces	Conditionnement
12460	1	6	SACHET



Informations techniques	
L	23.5 mm
B	10 mm
h	17.3 mm
d3	4 mm
D1	6.7 mm
F1	2 mm

Matières

POLYACETAL