

1 Allée des Bouleaux -F-95110 SANNOIS
 +33 (0)1 39 98 55 00
 info@restagraf.com

MIDI-ZEKERING 125A

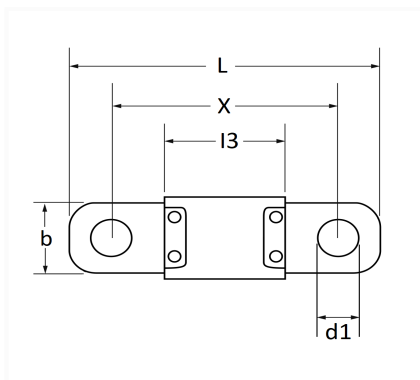

Item code	Number of References	Number of pieces	Conditioning
317137	1	10	
17137	1	2	
225085	1	1	



Technical informations	
L	41 mm
b	10 mm
X	30 mm
d1	5.4 mm
l3	16 mm
Intens.	125 A

Materials
VERTIND KOPER

Manufacturer correspondence*			
AUDI	N10525507	FIAT	10404490

Manufacturer correspondence*			
FORD Finis	1148218	FORD Ontwerpnumen	2S6T14A094HA
HYUNDAI	1898005931	JAGUAR	T2H36079
KIA	1898005931	LAND ROVER	LR080474
MAZDA	GS1E67099	MERCEDES-BENZ	N000000000416
MERCEDES-BENZ	N000000006633	OPEL (GM) Catalogusnummer	6235741
OPEL (GM) Onderdeelnummer	13133871	OPEL (GM) Onderdeelnummer	95525690
PEUGEOT / CITROËN	6500FJ	PEUGEOT / CITROËN	6500JC
PEUGEOT / CITROËN	6500S3	PEUGEOT / CITROËN	9665408580
TESLA	106219300A	TESLA	107137912A
TOYOTA	9098208297	VOLKSWAGEN	N10525507
VOLVO	9441941		

* Non contractual information given as indication