

COSSE RONDE NUE Ø 4 mm (1 → 2,5 mm²)

Code article	Nb de références	Nb de pièces	Conditionnement
306813	1	100	BOÎTE
6813	1	30	SACHET
226813	1	10	BLISTER

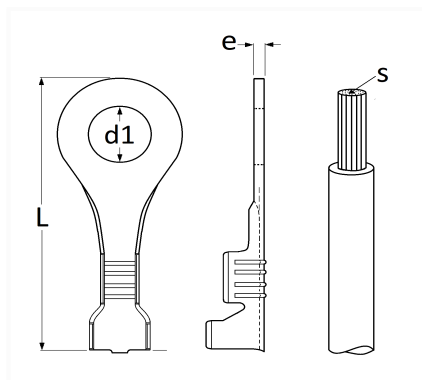

Informations techniques	
L	20.3 mm
d1	4.2 mm
e	0.5 mm
s	1 → 2.5 mm ²

Matières
LAITON