

1 Allée des Bouleaux -F-95110 SANNOIS  
+33 (0)1 39 98 55 00  
info@restagraf.com

## CALE DE LEVAGE 160 X 120 X 76 mm PONT ÉLÉVATEUR

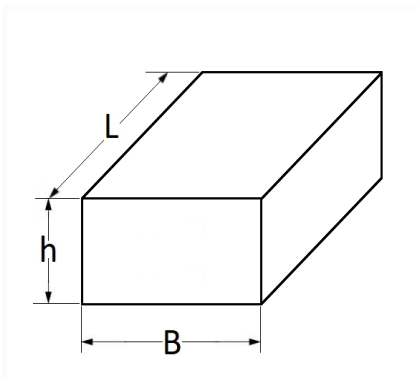

Code article	Nb de références	Nb de pièces	Conditionnement
40953	1	1	FILMÉ



Informations techniques	
L	155 mm
B	114 mm
h	76 mm

Matières

CAOUTCHOUC