

1 Allée des Bouleaux -F-95110 SANNOIS
 +33 (0)1 39 98 55 00
 info@restagraf.com

TRESSE DE MASSE L = 600 mm

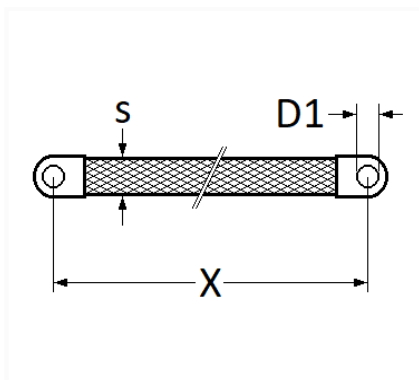

Code article	Nb de références	Nb de pièces	Conditionnement
17231	1	1	SACHET



Informations techniques	
X	600 mm
D1	10.2 mm
s	20 mm ²

Matières

CUIVRE