

BOBINE DE 25 MÈTRES DE FIL ÉLECTRIQUE 5 mm² ROUGE

Code article	Nb de références	Nb de pièces	Conditionnement
16241	1	1	BOBINE

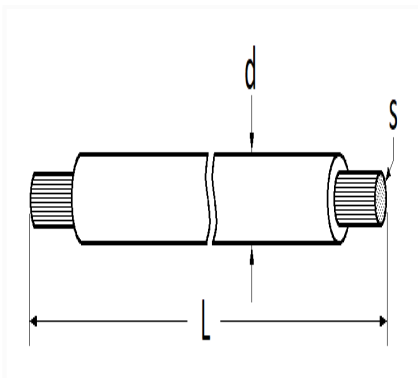

Informations techniques	
L	25 m
d	4.40 mm
s	5 mm ²

Matières
CUIVRE