

1 Allée des Bouleaux -F-95110 SANNOIS  
+33 (0)1 39 98 55 00  
info@restagraf.com

## MOUSSE ADHÉSIVE ANTIVIBRATIONS 297 X 210 X 8 mm EXTRA SOUPLE

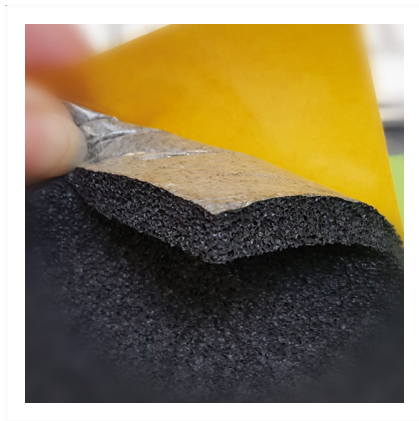

Code article	Nb de références	Nb de pièces	Conditionnement
3203	1	1	SACHET

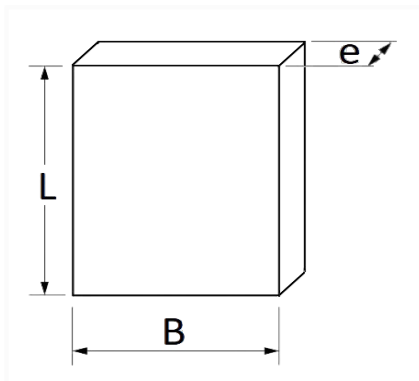

Informations techniques	
L	297 mm
B	210 mm
e	8 mm

### Matières

ETHYLENE PROPYLENE DIENE MONO.

