

1 Allée des Bouleaux -F-95110 SANNOIS
 +33 (0)1 39 98 55 00
 info@restagraf.com

BRIDE D'ÉCHAPPEMENT EN U Ø 38 mm

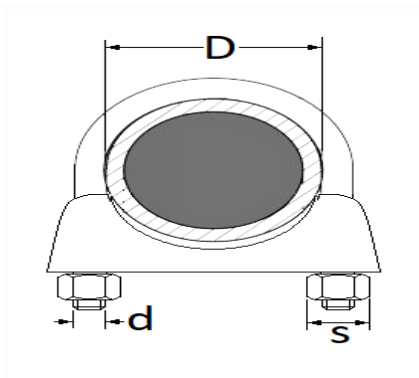

Code article	Nb de références	Nb de pièces	Conditionnement
974	1	2	SACHET
1974	1	10	BOÎTE



Informations techniques	
D	38 mm
d	M8 x 1.25
s	13 mm

Matières

ACIER