

1 Allée des Bouleaux -F-95110 SANNOIS
 +33 (0)1 39 98 55 00
 info@restagraf.com

GRADE 8.8 ZINC PLATED HEXAGON SOCKET HEAD CAP SCREW M10-1.50 X 30 mm DIN 912

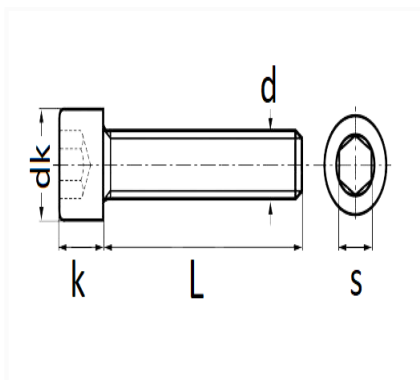

Item code	Number of References	Number of pieces	Conditioning
898	1	10	BAG



Technical informations	
dk	16 mm
k	10 mm
s	8 mm
L	30 mm
d	M10 x 1.50

Materials
CLASS 8.8 STEEL