

1 Allée des Bouleaux -F-95110 SANNOIS
 +33 (0)1 39 98 55 00
 info@restagraf.com

VIS À MÉTAUX TÊTE CHC CL8.8 ZN BLANC M6-1.00 X 10 mm DIN 912

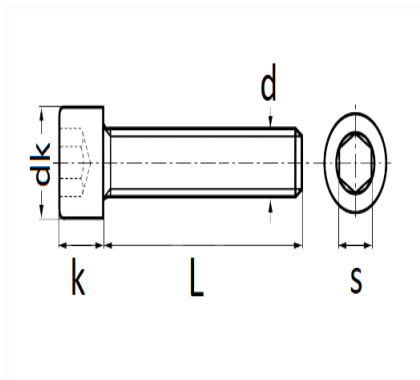

Code article	Nb de références	Nb de pièces	Conditionnement
884	1	30	SACHET



Informations techniques	
dk	10 mm
k	6 mm
s	5 mm
L	10 mm
d	M6 x 1.00

Matières

ACIER CLASSE 8.8