

1 Allée des Bouleaux -F-95110 SANNOIS  
 +33 (0)1 39 98 55 00  
 info@restagraf.com

## VIS TÊTE H À EMBASE CL8.8 M8-1.25 X 40 mm DIN 6921

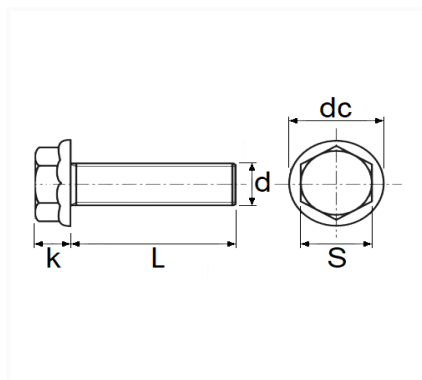

Code article	Nb de références	Nb de pièces	Conditionnement
228312	1	5	BLISTER
7171	1	10	SACHET



Informations techniques	
s	13 mm
k	8.1 mm
dc	18 mm
L	40 mm
d	M8 x 1.25

### Matières

ACIER CLASSE 8.8