

**VIS TÊTE H À EMBASE CL8.8 M6-1.00 X 30 mm DIN 6921**

Code article	Nb de références	Nb de pièces	Conditionnement
228307	1	5	BLISTER
7166	1	10	SACHET

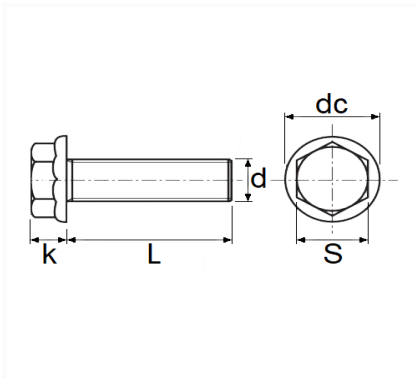

Informations techniques	
s	10 mm
k	6.6 mm
dc	14.2 mm
L	30 mm
d	M6 x 1.00

**Matières**

ACIER CLASSE 8.8