

**VIS TÊTE H À EMBASE CL8.8 M5-0.80 X 20 mm DIN 6921**

Code article	Nb de références	Nb de pièces	Conditionnement
228302	1	5	BLISTER
7161	1	20	SACHET

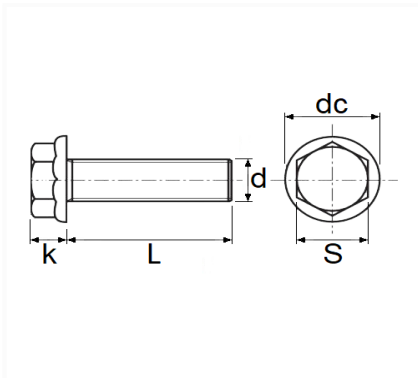

Informations techniques	
s	8 mm
k	5.4 mm
dc	11.8 mm
L	20 mm
d	M5 x 0.80

**Matières**

ACIER CLASSE 8.8