

1 Allée des Bouleaux -F-95110 SANNOIS  
 +33 (0)1 39 98 55 00  
 info@restagraf.com

## VIS À MÉTAUX TÊTE FENDUE M5-0.80 X 16 mm DIN 84

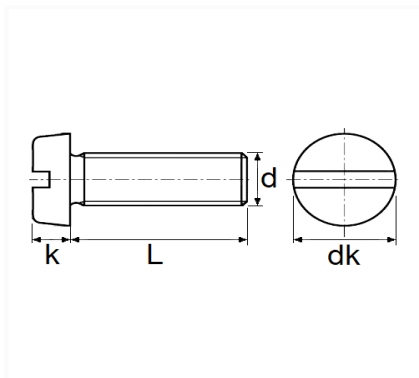

Code article	Nb de références	Nb de pièces	Conditionnement
756	1	65	SACHET



Informations techniques	
dk	8.5 mm
k	3.3 mm
L	16 mm
d	M5 x 0.80

### Matières

ACIER