

1 Allée des Bouleaux -F-95110 SANNOIS  
 +33 (0)1 39 98 55 00  
 info@restagraf.com

WORMSCHROEFKLEM Ø 60 → 80 mm L = 12 mm DIN 3017

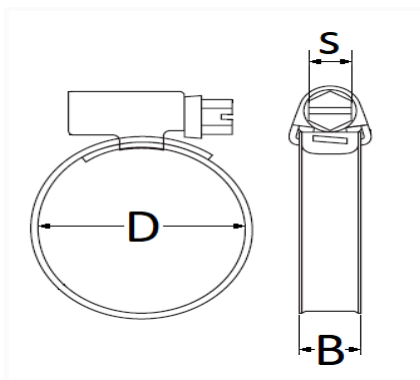

Item code	Number of References	Number of pieces	Conditioning
40718	1	10	
7563	1	2	



Technical informations	
D	60 → 80 mm
B	12 mm
s	7 mm

Materials
ROESTVRIJ STAAL W2