

1 Allée des Bouleaux -F-95110 SANNOIS
 +33 (0)1 39 98 55 00
 info@restagraf.com

COLLIER À VIS TANGENTE Ø 40 → 60 mm L = 12 mm DIN 3017

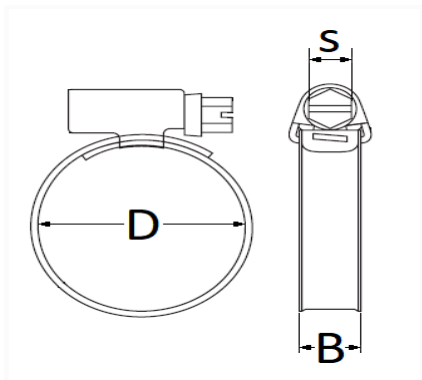

Code article	Nb de références	Nb de pièces	Conditionnement
40716	1	15	BOÎTE
7561	1	2	SACHET



Informations techniques	
D	40 → 60 mm
B	12 mm
s	7 mm

Matières

ACIER INOXYDABLE W2