

1 Allée des Bouleaux -F-95110 SANNOIS  
 +33 (0)1 39 98 55 00  
 info@restagraf.com

## COLLIER À VIS TANGENTE Ø 60 → 80 mm L = 9 mm DIN 3017

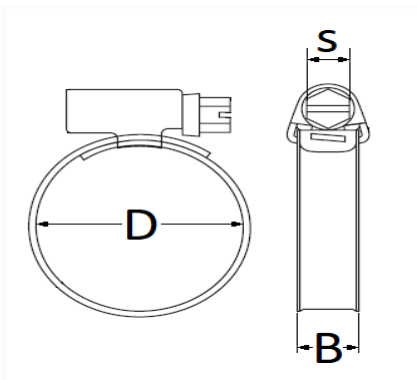

Code article	Nb de références	Nb de pièces	Conditionnement
40709	1	20	BOÎTE
227552	1	2	SACHET



Informations techniques	
D	60 → 80 mm
B	9 mm
s	7 mm

### Matières

ACIER INOXYDABLE W2