

ÉCROU HEXAGONAL AUTO-FREINÉ À BAGUE NYLON CL10 M20-1.50 DIN 985

Code article	Nb de références	Nb de pièces	Conditionnement
40446	1	10	BOÎTE

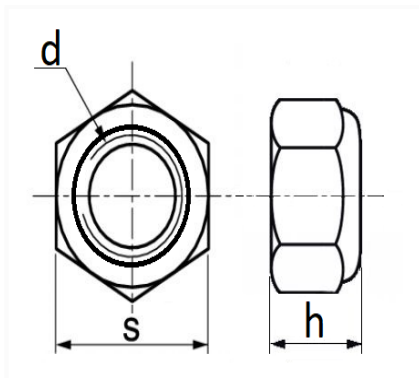

Informations techniques	
s	30 mm
h	20 mm
d	M20 x 1.50

Matières

ACIER CLASSE 10