

1 Allée des Bouleaux -F-95110 SANNOIS  
+33 (0)1 39 98 55 00  
info@restagraf.com

## ÉCROU HEXAGONAL CL10 M20-1.50 DIN 934

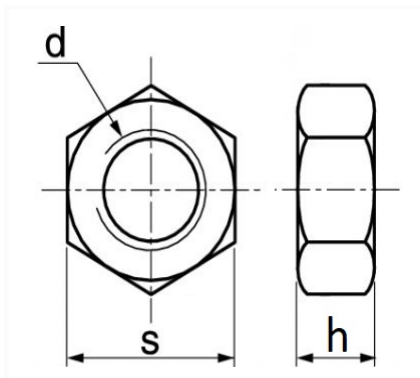

Code article	Nb de références	Nb de pièces	Conditionnement
40440	1	10	BOÎTE



Informations techniques	
s	30 mm
h	16 mm
d	M20 x 1.50

### Matières

ACIER CLASSE 10