

1 Allée des Bouleaux -F-95110 SANNOIS
 +33 (0)1 39 98 55 00
 info@restagraf.com

GRADE 10 HEXAGON NUT M18-1.50 DIN 934

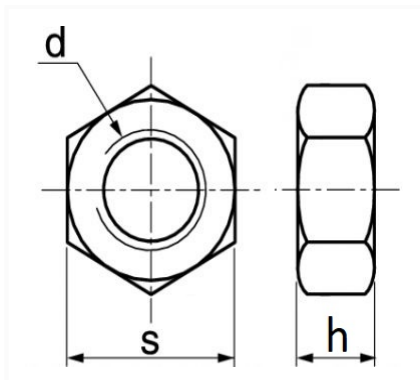

Item code	Number of References	Number of pieces	Conditioning
40439	1	10	BOX



Technical informations	
s	27 mm
h	15 mm
d	M18 x 1.50

Materials
CLASS 10 STEEL