

1 Allée des Bouleaux -F-95110 SANNOIS
 +33 (0)1 39 98 55 00
 info@restagraf.com

ÉCROU HEXAGONAL AUTO-FREINÉ À BAGUE NYLON CL10 M16-2.00 DIN 982

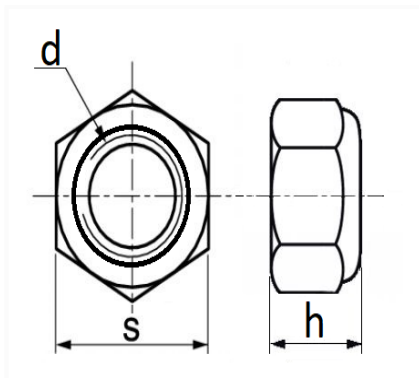

Code article	Nb de références	Nb de pièces	Conditionnement
40427	1	20	BOÎTE



Informations techniques	
s	24 mm
h	19.1 mm
d	M16 x 2.00

Matières

ACIER CLASSE 10