

VIS À MÉTAUX TÊTE CHC CL8.8 ZN NOIR M10-1.50 X 30 mm DIN 912

Code article	Nb de références	Nb de pièces	Conditionnement
40273	1	40	BOÎTE

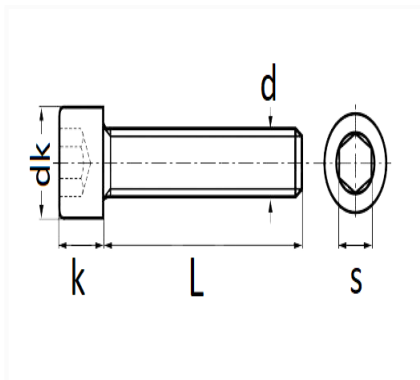

Informations techniques	
dk	16 mm
k	10 mm
s	8 mm
L	30 mm
d	M10 x 1.50

Matières

ACIER CLASSE 8.8