

1 Allée des Bouleaux -F-95110 SANNOIS  
 +33 (0)1 39 98 55 00  
 info@restagraf.com

**MASCHINENSCHRAUBE HALBRUNDKOPF KREUZSCHLITZ M8-1.25 X 50 mm NFE 25-129**

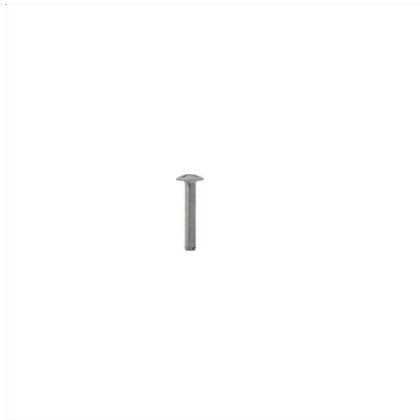

Item code	Number of References	Number of pieces	Conditioning
40239	1	50	BEHÄLTER

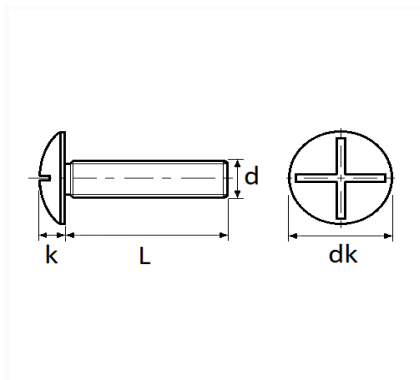

Technical informations	
dk	18 à 20 mm
k	4.2 mm
L	50 mm
d	M8 x 1.25

Materials
STAHL 4.8