

1 Allée des Bouleaux -F-95110 SANNOIS
 +33 (0)1 39 98 55 00
 info@restagraf.com

VIS À MÉTAUX TÊTE H CL10.9 M16-2.00 X 80 mm DIN 931 PARTIELLEMENT FILETÉE

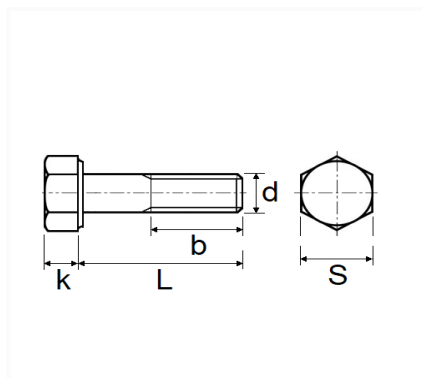

Code article	Nb de références	Nb de pièces	Conditionnement
40150	1	8	BOÎTE



Informations techniques	
s	24 mm
k	10 mm
b	38 mm
L	80 mm
d	M16 x 2.00

Matières

ACIER CLASSE 10.9