

1 Allée des Bouleaux -F-95110 SANNOIS
+33 (0)1 39 98 55 00
info@restagraf.com

VIS À MÉTAUX TÊTE H CL8.8 ZN BLANC M10-1.50 X 50 mm DIN 931 PARTIELLEMENT FILETÉE

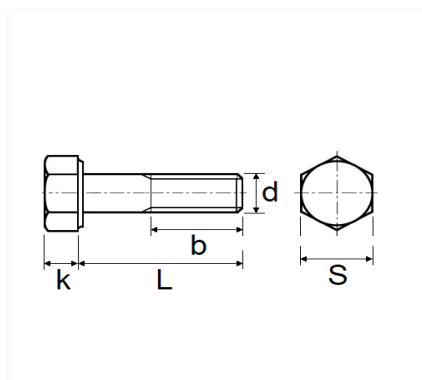

Code article	Nb de références	Nb de pièces	Conditionnement
40132	1	50	BOÎTE



Informations techniques	
s	17 mm
k	6.4 mm
b	26 mm
L	50 mm
d	M10 x 1.50

Matières

ACIER CLASSE 8.8