

VIS À MÉTAUX TÊTE H CL8.8 ZN BLANC M16-2.00 X 50 mm DIN 933

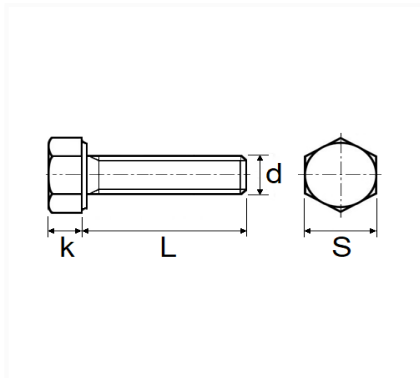

Code article	Nb de références	Nb de pièces	Conditionnement
7647	1	4	SACHET
7607	1	6	SACHET



Informations techniques	
s	24 mm
k	10 mm
L	50 mm
d	M16 x 2.00

Matières
ACIER CLASSE 8.8