

1 Allée des Bouleaux -F-95110 SANNOIS
 +33 (0)1 39 98 55 00
 info@restagraf.com

WORMSCHROEFKLEM Ø 32 → 50 mm L = 12 mm DIN 3017

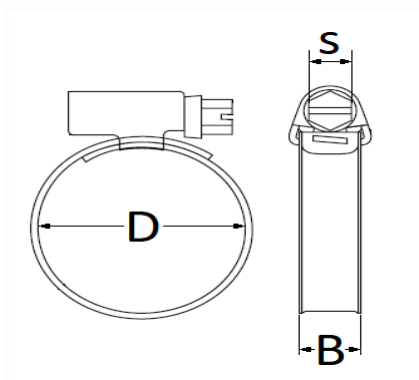

Item code	Number of References	Number of pieces	Conditioning
7560	1	2	
40715	1	8	



Technical informations	
D	32 → 50 mm
B	12 mm
s	7 mm

Materials
ROESTVRIJ STAAL W2