

VIS TÊTE H À EMBASE CL8.8 M8-1.25 X 40 mm DIN 6921

Code article	Nb de références	Nb de pièces	Conditionnement
7171	1	10	SACHET
228312	1	5	BLISTER

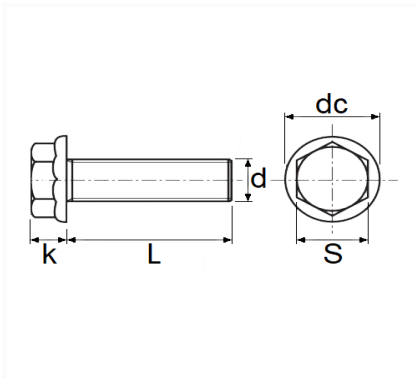

Informations techniques	
s	13 mm
k	8.1 mm
dc	18 mm
L	40 mm
d	M8 x 1.25

Matières

ACIER CLASSE 8.8