

1 Allée des Bouleaux -F-95110 SANNOIS
 +33 (0)1 39 98 55 00
 info@restagraf.com

VIS TÊTE H À EMBASE CL8.8 M6-1.00 X 30 mm DIN 6921

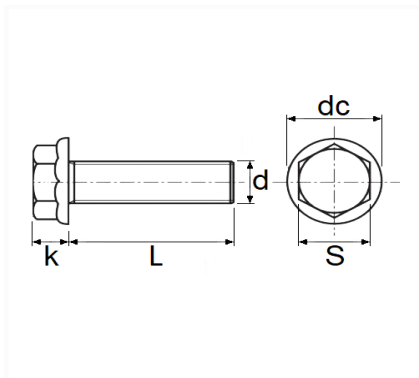

Code article	Nb de références	Nb de pièces	Conditionnement
7166	1	10	SACHET
228307	1	5	BLISTER



Informations techniques	
s	10 mm
k	6.6 mm
dc	14.2 mm
L	30 mm
d	M6 x 1.00

Matières

ACIER CLASSE 8.8