

1 Allée des Bouleaux -F-95110 SANNOIS  
 +33 (0)1 39 98 55 00  
 info@restagraf.com

**SCHRAUBE 8.8 AUßENSECHSKANT MIT FLANSCH M5-0.80 X 20 mm DIN 6921**

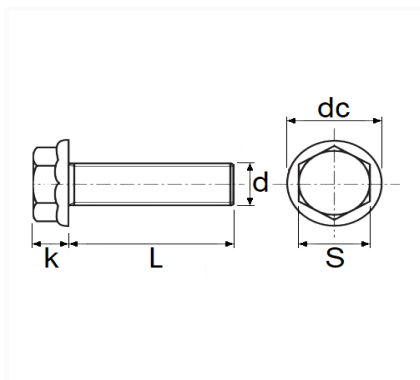

Item code	Number of References	Number of pieces	Conditioning
7161	1	20	BEUTEL
228302	1	5	BLISTER



Technical informations	
s	8 mm
k	5.4 mm
dc	11.8 mm
L	20 mm
d	M5 x 0.80

Materials
STAHL 8.8